

# st<sup>ar</sup>®

seating systems



PRODUCT CATALOG



DRIVER SEATS FOR TRACTOR, FORKLIFT, AGRICULTURE AND SPECIAL VEHICLES

## ABOUT US

**AKKOMSAN OTOMOTIV LTD. STI.** has founded as a small workshop in 1978 by two brothers in Aksehir, Konya (Turkey).

We have been manufacturing various operator and driver seats for tractors, forklifts and heavy-duty machines with brand of "**STAR**" since 1992.

Today, AKKOMSAN is one of the top manufacturer and exporter of Turkey also Middle East. We are one of the most admirable brand with our experience over 45 years, wide product range, patented desings, styles, quality and price.

Our company has ISO 9001:2015 Certification.

The necessity of Quality Management Systems (QMS), **AKKOMSAN OTOMOTIV** proved its high quality products by manufacturing type approval (e Type Certified) seats according to EU norms in current production plants total 30.400m<sup>2</sup> closed area.

Our whole production plants equipped with the latest high technology manufacturing equipments to meet the customers demands with a high satisfaction.

Our aims are; to continue the investments for the purpose of sustained and controlled growth, to upgrade the production capacity and product range, have the new and creative designs with high quality seats and to make "**STAR**" well known brand on global market.



*"STAR is a trademark of AKKOMSAN"*



**WIDE  
RANGE  
USAGE**

# INDEX

ECO TYPE MECHANISM	4
MULTI-FUNCTIONAL MECHANISM	10
03SM MECHANISM	12
11SM MECHANISM [Angle Adjustment]	15
05/06SM MECHANISM [Height Adjustment]	18
SP 12-TV1 MECHANISM [Scissor Type, Narrow - Wide Mechanical Suspension]	21
SP 12-TV4 MECHANISM [Scissor Type, Wide Mechanical Suspension]	25
SP 12-TV2 MECHANISM [Scissor Type, Narrow Pneumatic Suspension]	29
SP 12-TV3 MECHANISM [Scissor Type, Wide Pneumatic Suspension]	32
SP 12-TV5 MECHANISM [Scissor Type, Wide Pneumatic Suspension]	35
SP 12-TV6 MECHANISM [Scissor Type, Wide Pneumatic Suspension]	37
OPERATOR SEAT WITH JOYSTICK	39
SP 12-FSV1LS / FSV2LS [Scissor Type, LOW Mechanical / Pneumatic Suspension]	41
SP 12-DRV3 MECHANISM [Scissor Type, Wide AIR Suspension]	45
W/O SUSPENSION	47
TRACTOR PASSENGER SEAT	52
PLASTIC CONTRUCTION / GATOR SEAT	54
TRACTOR PTO / AIR COMPRESSOR	57
RESEARCH & DEVELOPMENT	58
SPARE PARTS & ACCESSORIES	59

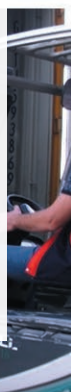

ECO TYPE

# ECO-01SM MECHANISM

W/O Fore/Aft Adjustment - Universal Fitting

- **Mechanical Suspension** with couple springs & hydraulic shock-absorber
- **80mm Suspension Stroke**
- **W/O Fore/Aft Adjustment**
- **50-120kg Operator Weight Adjustment**
- **102° Fixed Base Angle**



Weight Adjustment Knob



Universal Base Plate



Couple  
Springs



Hydraulic  
Shock  
Absorber



Manual  
Weight  
Adjustment



**ECO 101**

C. Width  
Backrest 485mm  
480mm

Base Angle

102°



Wraparound Backrest

**ECO 102**

C. Width  
Backrest 485mm  
570mm

Base Angle

102°

## Comfortable and Durable!

- Seat and backrest upholstery combining different setting functions are available.
- **Wraparound backrest and seat raised at sides to ensure good holding even when travelling over rough or sloping terrain.**
- Expanded polyurethane padding with washable covering.
- **Metal structures protected against corrosion with electrostatic powder coating in conformity with the quality standards of the EU industry.**
- The height and weight in the mechanism can be easily adjusted with just a few quick movements. The control elements are functionally arranged and easy to use.
- **Every detail (low friction joints, bearings, materials, settings, painting, strength, dynamic response, comfort, etc.) has been designed with special care in order to increase the reliability and the product life span.**



\* Plastic Construction  
\* Corrosion Resistant

**ECO 101P**

C. Width  
Backrest 485mm  
480mm

Base Angle

102°



Without PVC Seal Strips



Eco-friendly Plastic Design

Corroded



\* Metal Construction (Wraparound BACKREST)  
\* Plastic Construction (Seat Cushion) Corrosion Resistant

**ECO 102P**

C. Width  
Backrest 485mm  
570mm

Base Angle

102°

ECO TYPE

# ECO-03SM MECHANISM

Universal Fitting

- **Mechanical Suspension** with couple springs & hydraulic shock-absorber
- **80mm Suspension Stroke**
- **150mm Sliding Base Adjustment**
- **50-120kg Operator Weight Adjustment**
- **102° Base Angle**

Weight Adjustment Knob



Fore/Aft Handle

Universal Base Plate



Couple  
Springs



Hydraulic  
Shock  
Absorber



Fore/aft  
Adjustment



Manual  
Weight  
Adjustment



<b>ECO 103</b>	C. Width Backrest	485mm 480mm
Base Angle		102°

Wraparound Backrest



<b>ECO 104</b>	C. Width Backrest	485mm 570mm
Base Angle		102°

Without PVC Seal Strips



**ECO FRIENDLY**

- \* Plastic Construction
- \* Corrosion Resistant

<b>ECO 10339</b>	C. Width Backrest	390mm
Base Angle		102°

Without PVC Seal Strips



**ECO FRIENDLY**

- \* Plastic Construction
- \* Corrosion Resistant

<b>ECO 103P</b>	C. Width Backrest	485mm 480mm
Base Angle		102°

Without PVC Seal Strips



**ECO FRIENDLY**

- \* Metal Construction (Wraparound BACKREST)
- \* Plastic Construction (Seat Cushion) Corrosion Resistant

<b>ECO 104P</b>	C. Width Backrest	485mm 570mm
Base Angle		102°

Without PVC Seal Strips



**ECO FRIENDLY**

- \* Plastic Construction
- \* Corrosion Resistant

<b>ECO P10345</b>	C. Width Backrest	450mm
Base Angle		102°



For JOHN DEERE

<b>ECO 109</b>	C. Width Backrest	485mm 480mm
Base Angle		116°



For JOHN DEERE

Wraparound Backrest

<b>ECO 109A</b>	C. Width Backrest	485mm 570mm
Base Angle		116°



ECO TYPE

# ECO - 11SM MECHANISM

MULTI-FUNCTIONAL MECHANISM - Universal Fitting

- **Mechanical Suspension** with couple springs & hydraulic shock-absorber
- **80mm Suspension Stroke**
- **150mm Sliding Base Adjustment**
- **50-120kg Operator Weight Adjustment**
- **Multi Angle Base for 5 Position**

Weight Adjustment Knob



Angle Holes

Fore/Aft Handle

Universal Base Plate



Couple Springs



Hydraulic Shock Absorber



Fore/aft Adjustment



Manual Weight Adjustment





Wraparound Backrest

<b>ECO 110</b>	C. Width Backrest	485mm 570mm
Base Angle	102°-116°-118°-120°-142°	



<b>ECO 111</b>	C. Width Backrest	485mm 480mm
Base Angle	102°-116°-118°-120°-142°	

Without PVC Seal Strips



**ECO FRIENDLY**  
\* Plastic Construction  
\* Corrosion Resistant

<b>ECO 11139</b>	C. Width Backrest	390mm
Base Angle	102°-116°-118°-120°-142°	

Without PVC Seal Strips



**ECO FRIENDLY**  
\* Plastic Construction  
\* Corrosion Resistant

<b>ECO 111P</b>	C. Width Backrest	420mm 445mm
Base Angle	102°-116°-118°-120°-142°	

Without PVC Seal Strips



**ECO FRIENDLY**  
\* Plastic Construction  
\* Corrosion Resistant

\* Metal Construction (Wraparound BACKREST)  
\* Plastic Construction (Seat Cushion) Corrosion Resistant

<b>ECO 110P</b>	C. Width Backrest	445mm 565mm
Base Angle	102°-116°-118°-120°-142°	

Without PVC Seal Strips



<b>ECO 11145</b>	C. Width Backrest	450mm
Base Angle	102°-116°-118°-120°-142°	

Without PVC Seal Strips



**ECO FRIENDLY**  
\* Plastic Construction  
\* Corrosion Resistant

<b>ECO P11145</b>	C. Width Backrest	450mm
Base Angle	102°-116°-118°-120°-142°	

The seat mechanism has a multifunctional structure as provide various angles. This feature support fast and easy fixing according to the mounting angle of your vehicle for multiple holes.



ECO TYPE

# 11-05SM MECHANISM

MULTI-FUNCTIONAL MECHANISM - Universal Fitting

- **Mechanical Suspension** with couple springs & hydraulic shock-absorber
- **80mm Suspension Stroke**
- **30mm Height Adjustment**
- **150mm Sliding Base Adjustment**
- **50-120kg Operator Weight Adjustment**
- **Multi Angle Base for 5 Position**

Weight Adjustment Knob



				
Couple Springs	Hydraulic Shock Absorber	Height Adjustment	Fore/aft Adjustment	Manual Weight Adjustment

# MULTI-FUNCTIONAL MECHANISM

Angle and Height Adjustment



<b>ST 11-05BS</b>	C. Width Backrest	490mm 480mm
Height Adjustment		30mm
Base Angle		102°-116°-118°-120°-142°

Without PVC Seal Strips

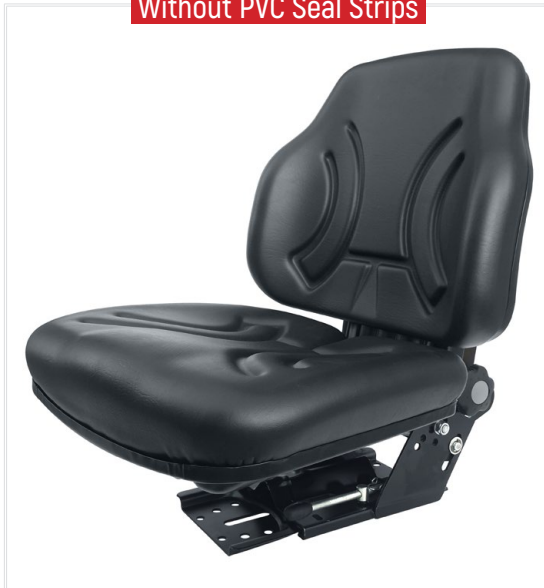

<b>ST 11-0545</b>	C. Width Backrest	450mm 450mm
Height Adjustment		30mm
Base Angle		102°-116°-118°-120°-142°



Without PVC Seal Strips

**ECO FRIENDLY**  
 \* Plastic Construction  
 \* Corrosion Resistant



<b>ST 11-0545P</b>	C. Width Backrest	450mm 450mm
Height Adjustment		30mm
Base Angle		102°-116°-118°-120°-142°



# STAR TYPE 03SM MECHANISM

Universal Fitting

- **Mechanical Suspension** with couple springs & hydraulic shock-absorber
- **80mm Suspension Stroke**
- **150mm Sliding Base Adjustment**
- **50-120kg Operator Weight Adjustment**
- **102° Base Angle**

Weight Adjustment Knob



**STRONGER CONSTRUCTION**



Couple  
Springs



Hydraulic  
Shock  
Absorber



Fore/aft  
Adjustment



Manual  
Weight  
Adjustment



**ST 03**

C. Width Backrest 485mm  
480mm



Wraparound Backrest

**ST 04**

C. Width Backrest 485mm  
570mm

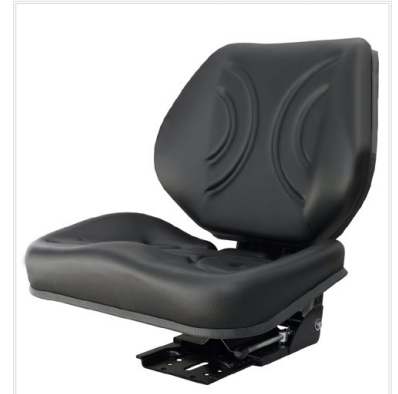

**ST 03BS**

C. Width Backrest 490mm  
480mm

Without PVC Seal Strips



\* Plastic Construction  
\* Corrosion Resistant



Lower Seating Position

**ST 0339**

C. Width Backrest 390mm

Without PVC Seal Strips



**ST 0342**

C. Width Backrest 420mm

Without PVC Seal Strips



**ST 0345**

C. Width Backrest 450mm



Pan Type Seat  
Overturnable Cushion  
Water Drainage System

**ST C11**

C. Width Backrest 490mm



Pan Type Seat  
Overturnable Cushion  
Water Drainage System

**ST GC11**

C. Width Backrest 390mm



**ST 08**

C. Width	485mm
Backrest	480mm

For STEYR



Wraparound Backrest

**ST 08A**

C. Width	485mm
Backrest	570mm

For STEYR



Pan Type Seat  
Water Drainage System

**ST C08**

C. Width	490mm
Backrest	

For STEYR



**ST 09**

C. Width	485mm
Backrest	480mm

For JOHN DEERE



Wraparound Backrest

**ST 09A**

C. Width	485mm
Backrest	570mm

For JOHN DEERE



Pan Type Seat  
Overturnable Cushion  
Water Drainage System

**ST C09**

C. Width	490mm
Backrest	

For JOHN DEERE



Pan Type Seat  
Overturnable Cushion  
Water Drainage System

**ST CMF11**

C. Width	560mm
Backrest	

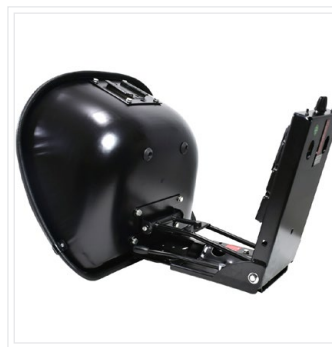

# STAR TYPE 11SM MECHANISM

Universal Fitting

- **Mechanical Suspension** with couple springs & hydraulic shock-absorber
- **80mm Suspension Stroke**
- **150mm Sliding Base Adjustment**
- **50-120kg Operator Weight Adjustment**
- **Multi Angle Base for 5 Position** 102°-116°-118°-120°-142°

Weight Adjustment Knob



**STRONGER CONSTRUCTION**



Angle Holes  
(5 Positions)

Fore/Aft Handle

Universal Base Plate



Couple  
Springs



Hydraulic  
Shock  
Absorber



Fore/aft  
Adjustment



Manual  
Weight  
Adjustment



Wraparound Backrest

**ST 10**

C. Width  
Backrest 485mm  
570mm



**ST 11**

C. Width  
Backrest 485mm  
480mm



**ST 11BS**

C. Width  
Backrest 490mm  
480mm

Without PVC Seal Strips



\* Plastic Construction  
\* Corrosion Resistant



**ST 1139**

C. Width  
Backrest 390mm

Without PVC Seal Strips



**ST 1142**

C. Width  
Backrest 420mm

Without PVC Seal Strips



**ST 1145**

C. Width  
Backrest 450mm

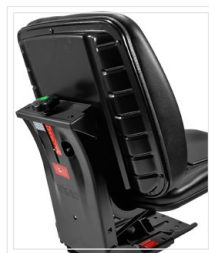

Without PVC Seal Strips



\* Plastic Construction  
\* Corrosion Resistant



**ST P1145**

C. Width  
Backrest 450mm

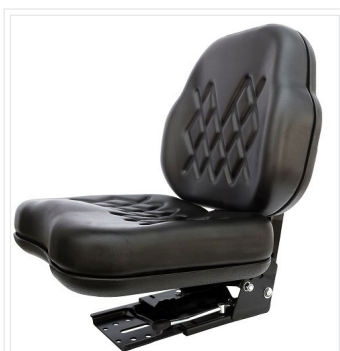

Foldable Seat Cushion

**ST 11DS**

C. Width  
Backrest 485mm  
480mm





<b>ST 11BS-07BE</b>	C. Width Backrest	490mm 480mm
Backrest Extension (SP01)		Standart
Foldable Armrest (YP15)		Standart



<b>ST 11-TV1</b>	C. Width Backrest	475mm 450mm
Backrest Adjustment		Back: 30°   Front: 85°



Pan Type Seat  
Overturnable Cushion  
Water Drainage System

<b>ST C10</b>	C. Width Backrest	490mm
Base Angle		102°-116°-118°-120°-142°



Pan Type Seat  
Overturnable Cushion  
Water Drainage System

<b>ST GC10</b>	C. Width Backrest	390mm
Base Angle		102°-116°-118°-120°-142°

# STAR TYPE 05/06SM MECHANISM

Homologation Series

- **Mechanical Suspension** with couple springs & hydraulic shock-absorber
- **100mm Suspension Stroke**
- **60mm Height Adjustment**
- **150mm Sliding Base Adjustment**
- **50-120kg Operator Weight Adjustment**
- **102° Base Angle**
- **1322/2014 (2018/830W2) EEC Homologation Certification**

Weight Adjustment Knob



**STRONGER CONSTRUCTION**



Couple Springs



Hydraulic Shock Absorber



Height Adjustment



Fore/aft Adjustment



Manual Weight Adjustment



Height Adjustment Knob  
60mm

Fore/Aft Handle

Universal Base Plate





Wraparound Backrest

<b>ST 05</b>	C. Width	485mm
	Backrest	570mm



<b>ST 05BS</b>	C. Width	490mm
	Backrest	480mm



<b>ST 06</b>	C. Width	485mm
	Backrest	480mm

Without PVC Seal Strips

**ECO FRIENDLY**  
 \* Plastic Construction  
 \* Corrosion Resistant



<b>ST 0639</b>	C. Width	390mm
	Backrest	



Without PVC Seal Strips



<b>ST 0642</b>	C. Width	420mm
	Backrest	



Without PVC Seal Strips



<b>ST 0645</b>	C. Width	450mm
	Backrest	

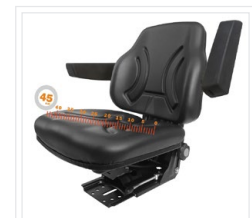

Without PVC Seal Strips



<b>ST P0645</b>	C. Width	450mm
	Backrest	





Seat Cushion Depth Adj.



<b>ST 05-TV140</b>	C. Width Backrest	400mm
Backrest Adjustment	Back: 30°   Front: 85°	
Seat Cushion Depth Adj.	40mm	

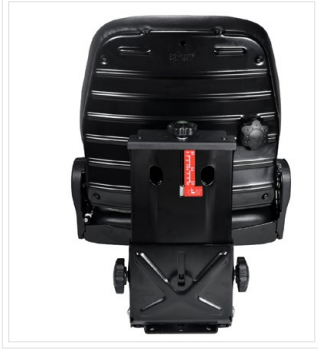

<b>ST 05-TV1</b>	C. Width Backrest	475mm 430mm
Backrest Adjustment	Back: 30°   Front: 85°	



Pan Type Seat  
Water Drainage System

<b>ST GC05</b>	C. Width Backrest	390mm
----------------	-------------------	-------



Foldable Cushion

For DEUTZ

<b>ST 13DS-05MP</b>	C. Width Backrest	485mm 480mm
---------------------	-------------------	----------------



Pan Type Seat  
Water Drainage System

<b>ST C05</b>	C. Width Backrest	490mm
---------------	-------------------	-------

# STARplus TYPE

# SP12-TV1 MECHANISM

HOMOLOGATED | Scissor Type, Narrow Mechanical Suspension

- Mechanical Suspension with four springs & hydraulic shock-absorber
- 100mm Suspension Stroke
- 80mm Height Adjustment
- 50-130kg Operator Weight Adjustment
- Universal Fixed Base
- **1322/2014 (2018/830W2) EEC Homologation Certification**



Height Adjustment Knob

Weight Adjustment Knob

Weight Adjustment Indicator

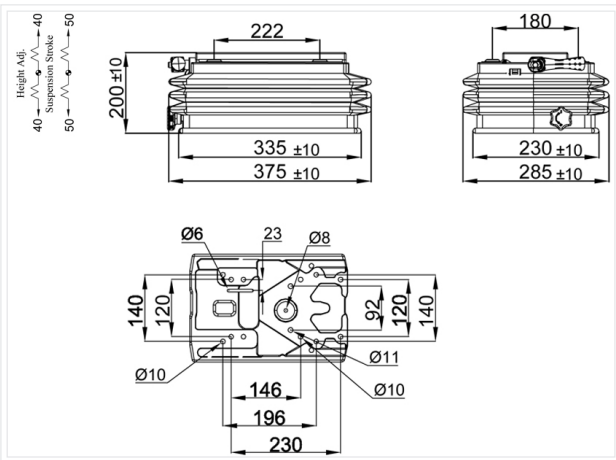

				
Four Springs	Hydraulic Shock Absorber	Height Adjustment	Manual Weight Adjustment	LOW Frequency Mechanism

Without PVC Seal Strips



- \* Plastic Construction
- \* Corrosion Resistant
- \* Without PVC Seal Strips



Anti-Corrosion

**STplus V39**

C. Width Backrest **FIXED** 390mm

Fore/aft Adjustment

min. 150mm

Without PVC Seal Strips



**STplus V42**

C. Width Backrest **FIXED** 420mm

Fore/aft Adjustment

min. 150mm

Without PVC Seal Strips



**STplus V45**

C. Width Backrest **FIXED** 450mm

Fore/aft Adjustment

min. 150mm

Without PVC Seal Strips



- \* Plastic Construction
- \* Corrosion Resistant
- \* Without PVC Seal Strips



**STplus PV45**

C. Width Backrest **FIXED** 450mm

Fore/aft Adjustment

min. 150mm



**STplus V03**

C. Width Backrest **FIXED** 485mm  
480mm

Fore/aft Adjustment

min. 150mm



**STplus BSV1**

C. Width Backrest **FIXED** 490mm  
470mm

Fore/aft Adjustment

min. 150mm



Pan Type Seat  
Water Drainage System

**STplus GC11**

C. Width Backrest **FIXED** 390mm

Fore/aft Adjustment

min. 150mm



Pan Type Seat  
Water Drainage System

**STplus C11**

C. Width Backrest **FIXED** 490mm

Fore/aft Adjustment

min. 150mm



Pan Type Seat  
Water Drainage System  
Plastic Construction For Seat Top

**STplus TV1846**

C. Width Backrest **FIXED** 460mm

Fore/aft Adjustment

min. 150mm

Anti-Corrosion



<b>STplus TV1</b>	Cushion Width Backrest	475mm 475mm
Fore/aft Adjustment	min. 150mm	
Backrest Adjustment	Back: 30°   Front: 85°	



<b>STplus TV1-LX</b>	Cushion Width Backrest	485mm 475mm
Fore/aft Adjustment	min. 150mm	
Backrest Adjustment	Back: 30°   Front: 85°	



<b>STplus TV140</b>	C. Width Backrest	400mm
Fore/aft Adjustment	min. 150mm	
Backrest Adjustment	Back: 30° Front: 85°	
Seat Cushion Depth Adj.	40mm	

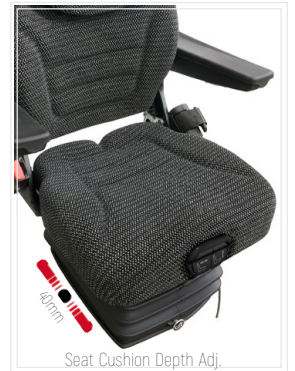
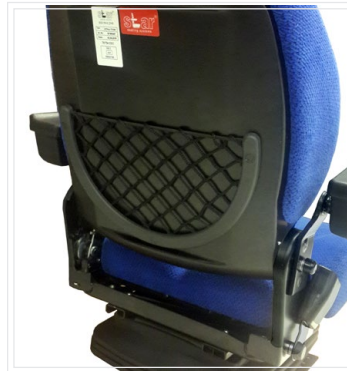

Backrest Adjustment  
Depth Adjustment



Trim Upholstery - Vinyl / Cloth (cut&sew)

**STplus TV1600**

C. Width Backrest	510mm
	<b>FIXED</b> 495mm

Fore/aft Adjustment	min. 125mm
---------------------	------------

Backrest Adjustment	Back: 80°   Front: 30°
---------------------	------------------------



Short Backrest

Trim Upholstery - Vinyl / Cloth (cut&sew)

**STplus TV1650**

C. Width Backrest	475mm
	465mm

Fore/aft Adjustment (With Double Lock)	min. 125mm
--	------------

Backrest Adjustment	Back: 42°   Front: 5°
---------------------	-----------------------

Certification	M2-M3   N2-N3
---------------	---------------



Long Backrest

Trim Upholstery - Vinyl / Cloth (cut&sew)

**STplus TV1730**

C. Width Backrest	475mm
	465mm

Fore/aft Adjustment (With Double Lock)	min. 125mm
--	------------

Backrest Adjustment	Back: 42°   Front: 5°
---------------------	-----------------------

Certification	M2-M3   N2-N3
---------------	---------------

Adjustable Seat Cushion (Fore and Aft. 70mm)



Adjustable Armrest  
20mm



Lumbar Adjustment



3P Automatic Seat Belt



Standard Covering

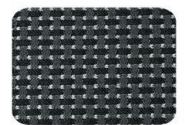

**SPRINTER CLOTH**  
Cloth Upholstery

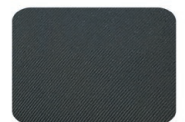

**BLACK CLOTH**  
Cloth Upholstery



STARplus TYPE

# SP12-TV4 MECHANISM

HOMOLOGATED | Scissor Type, Wide Mechanical Suspension

- **Mechanical Suspension** with couple springs & hydraulic shock-absorber
- **100mm Suspension Stroke**
- **80mm Height Adjustment**
- **50-150kg Operator Weight Adjustment**
- **Universal Fixed Base**
- **1322/2014 (2018/830W2) EEC Homologation Certification**





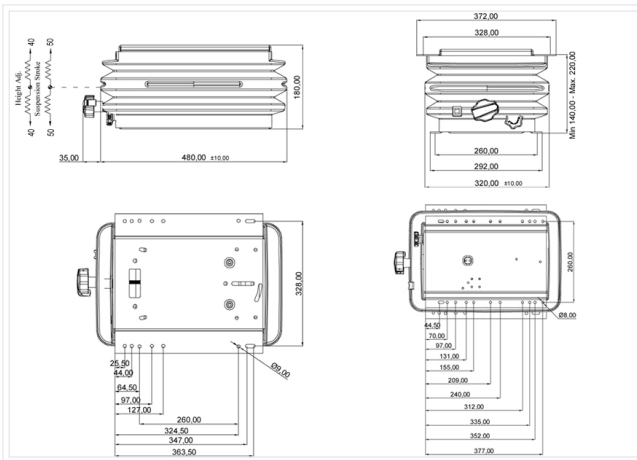

Height Adjustment Knob

Weight Adjustment Knob

Weight Adjustment Indicator



				
Couple Springs	Hydraulic Shock Absorber	Height Adjustment	Manual Weight Adjustment	LOW Frequency Mechanism



**STplus TV4**

C. Width 475mm  
Backrest 430mm

Fore/aft Adjustment  
(With Double Lock)

min. 190mm

Backrest Adjustment

Back: 30° | Front: 85°



**STplus TV4-LX**

C. Width 485mm  
Backrest 475mm

Fore/aft Adjustment  
(With Double Lock)

min. 190mm

Backrest Adjustment

Back: 30° | Front: 85°



Trim Upholstery - Vinyl / Cloth (cut&sew)

**STplus TV4600**

C. Width 510mm  
Backrest **FIXED** 495mm

Fore/aft Adjustment  
(With Double Lock)

min. 190mm

Backrest Adjustment

Back: 80° | Front: 30°



**NEW**



**3CTRL  
ADJUSTMENT**  
Depth | Tilt | Backrest

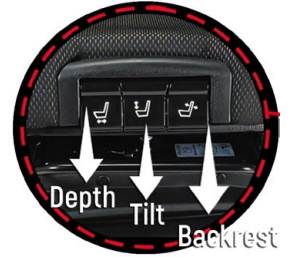

**STplus TV4-LX 3CTRL**

C. Width Backrest 520mm  
445mm

Fore/aft Adjustment	min. 190mm
Backrest Adjustment	Back: 30°   Front: 85°
Seat Cushion Depth Adjustment	40mm
Seat Cushion Tilt Adjustment	6°

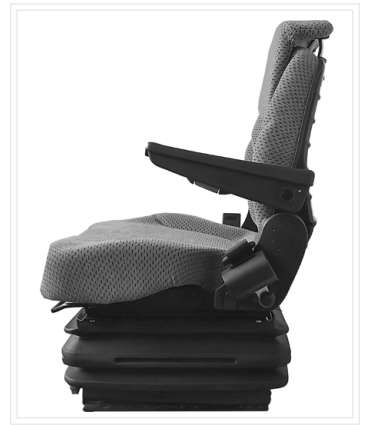

**NEW**

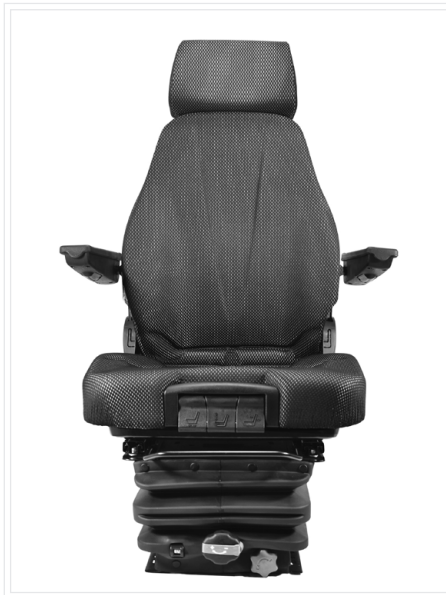

**STplus TV4700 3CTRL**

C. Width Backrest 520mm  
495mm

Fore/aft Adjustment	min. 190mm
Backrest Adjustment	Back: 30°   Front: 85°
Seat Cushion Depth Adjustment	40mm
Seat Cushion Tilt Adjustment	6°



**NEW**

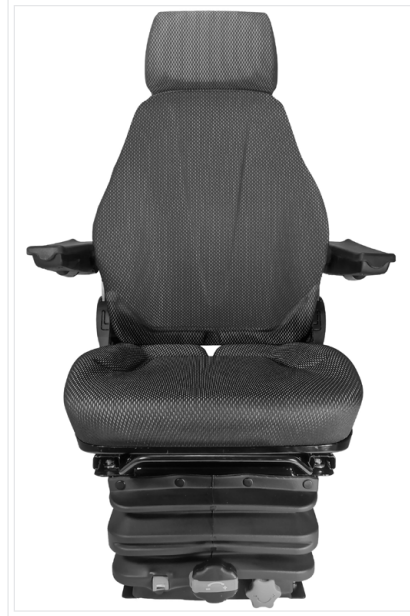

**STplus TV4700**

C. Width Backrest 500mm  
495mm

Fore/aft Adjustment (With Double Lock) min. 190mm

Backrest Adjustment Back: 30° | Front: 85°



Short Backrest  
Trim Upholstery - Vinyl / Cloth (cut&sew)

Long Backrest  
Trim Upholstery - Vinyl / Cloth (cut&sew)

**STplus TV4650**

C. Width Backrest 475mm  
465mm

Fore/aft Adjustment (With Double Lock) min. 190mm

Backrest Adjustment Back: 42° | Front: 5°

Certification M2-M3 | N2-N3

**STplus TV4730**

C. Width Backrest 475mm  
465mm

Fore/aft Adjustment (With Double Lock) min. 190mm

Backrest Adjustment Back: 42° | Front: 5°

Certification M2-M3 | N2-N3

Standard Covering



Adjustable Seat Cushion (Fore and Aft. 70mm)



3P Automatic Seat Belt



Lumbar Adjustment



Adjustable Armrest 20mm

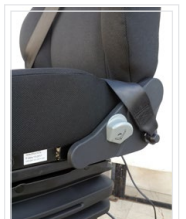

# STARplus TYPE

# SP12-TV2 MECHANISM

HOMOLOGATED | Scissor Type, Narrow Pneumatic Suspension

- **Pneumatic Suspension** with air spring & hydraulic shock-absorber  
With 12V or 24V | 9A Built-In Compressor
- **80mm Suspension Stroke**
- **50-150kg Manuel Operator Weight Adjustment**
- **Universal Fixed Base**
- **1322/2014 (2018/830W2) EEC Homologation Certification**

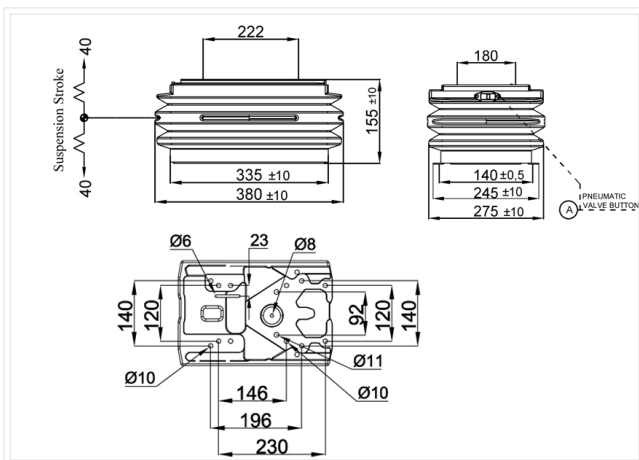

Air  
Springs



Hydraulic  
Shock  
Absorber



Weight  
Adjustment



LOW  
Frequency  
Mechanism

Without PVC Seal Strips



- \* Plastic Construction
- \* Corrosion Resistant
- \* Without PVC Seal Strips



Anti-Corrosion

**STplus V39AIR**

C. Width Backrest **FIXED** 390mm

Fore/aft Adjustment

min. 150mm

Without PVC Seal Strips



**STplus V42AIR**

C. Width Backrest **FIXED** 420mm

Fore/aft Adjustment

min. 150mm

Without PVC Seal Strips



**STplus V45AIR**

C. Width Backrest **FIXED** 450mm

Fore/aft Adjustment

min. 150mm

Without PVC Seal Strips



- \* Plastic Construction
- \* Corrosion Resistant
- \* Without PVC Seal Strips



Anti-Corrosion

**STplus P45AIR**

C. Width Backrest **FIXED** 450mm

Fore/aft Adjustment

min. 150mm



**STplus V03AIR**

C. Width Backrest **FIXED** 485mm / 480mm

Fore/aft Adjustment

min. 150mm



**STplus BSV2**

C. Width Backrest **FIXED** 490mm / 470mm

Fore/aft Adjustment

min. 150mm



Pan Type Seat  
Water Drainage System

**STplus GC12**

C. Width Backrest **FIXED** 390mm

Fore/aft Adjustment

70mm / 70mm



Pan Type Seat  
Water Drainage System

**STplus C12**

C. Width Backrest **FIXED** 490mm

Fore/aft Adjustment

min. 150mm



**STplus TV2**

Cushion Width Backrest 475mm  
475mm

Fore/aft Adjustment

min. 150mm

Backrest Adjustment

Back: 30° | Front: 85°

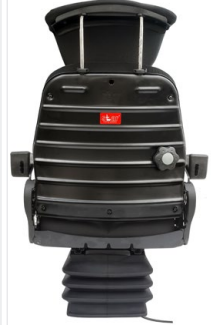

**STplus TV2-LX**

Cushion Width Backrest 485mm  
475mm

Fore/aft Adjustment

min. 150mm

Backrest Adjustment

Back: 30° | Front: 85°

**NEW**



Backrest Adjustment

Depth Adjustment

**STplus TV240**

C. Width Backrest 400mm

Fore/aft Adjustment

min. 150mm

Backrest Adjustment

Back: 30° Front: 85°

Seat Cushion Depth Adj.

40mm

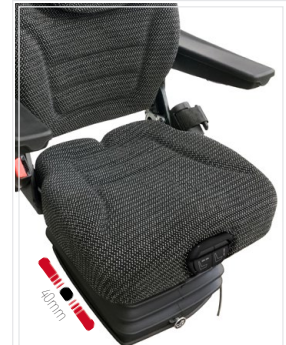
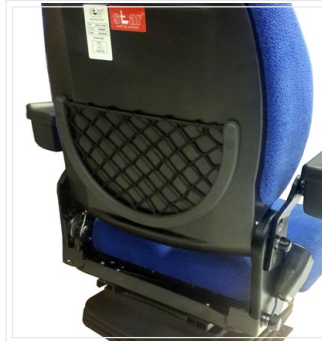

Seat Cushion Depth Adj.



# STARplus TYPE

# SP12-TV3 MECHANISM

HOMOLOGATED | Scissor Type, Wide Pneumatic Suspension

- **Pneumatic Suspension** with air spring & hydraulic shock-absorber  
With 12V or 24V | 9A Built-In Compressor
- 140mm Suspension Stroke
- 50-150kg Automatic Operator Weight Adjustment
- Fore/Aft Isolator With Damper 35mm Travel
- Universal Fixing Base
- **1322/2014 (2018/830W2) EEC Homologation Certification**



Fore/Aft Isolator Handle

Paddle Valve Button

Power Cable

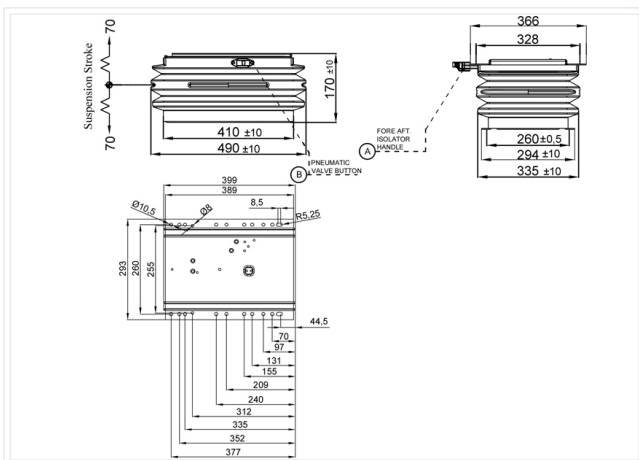

Air Springs



Hydraulic Shock Absorber



Fore/aft Isolator



Automatic Weight Adjustment



LOW Frequency Mechanism



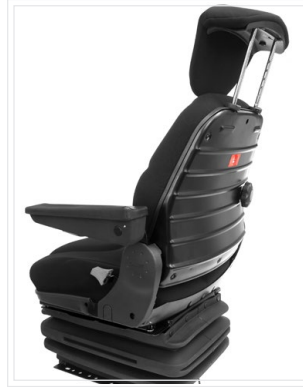

**STplus TV3**

C. Width Backrest	475mm 430mm
-------------------	----------------

Fore/aft Adjustment (With Double Lock)	min. 190mm
--	------------

Backrest Adjustment	Back: 30°   Front: 85°
---------------------	------------------------

**STplus TV3-LX**

C. Width Backrest	485mm 475mm
-------------------	----------------

Fore/aft Adjustment (With Double Lock)	min. 190mm
--	------------

Backrest Adjustment	Back: 30°   Front: 85°
---------------------	------------------------



**NEW**

**3CTRL**  
ADJUSTMENT  
Depth | Tilt | Backrest



Depth Adjustment  
Tilt Adjustment  
Backrest Adjustment

**STplus TV3-LX 3CTRL**

C. Width Backrest	520mm 445mm
-------------------	----------------

Fore/aft Adjustment (With Double Lock)	min. 190mm
--	------------

Backrest Adjustment	Back: 30°   Front: 85°
---------------------	------------------------

Seat Cushion Depth Adjustment	40mm
-------------------------------	------

Seat Cushion Tilt Adjustment	6°
------------------------------	----

**NEW**



Backrest Adjustment  
Depth Adjustment

**STplus TV340**

C. Width Backrest	400mm
-------------------	-------

Fore/aft Adjustment (With Double Lock)	min. 190mm
--	------------

Backrest Adjustment	Back: 30°   Front: 85°
---------------------	------------------------

Seat Cushion Depth Adjustment	40mm
-------------------------------	------



Seat Cushion Depth Adj.



NEW



**3CTRL**  
ADJUSTMENT  
Depth | Tilt | Backrest



NEW



**STplus TV3700**

C. Width Backrest 500mm  
495mm

Fore/aft Adjustment (With Double Lock) min. 190mm

Backrest Adjustment Back: 30° | Front: 85°

**STplus TV3700 3CTRL**

C. Width Backrest 520mm  
495mm

Fore/aft Adjustment (With Double Lock) min. 190mm

Backrest Adjustment Back: 30° | Front: 85°

Seat Cushion Depth Adjustment 40mm

Seat Cushion Tilt Adjustment 6°



Short Backrest  
Trim Upholstery - Vinyl / Cloth (cut&sew)

**STplus TV3650**

C. Width Backrest 475mm  
465mm

Fore/aft Adjustment (With Double Lock) min. 190mm

Backrest Adjustment Back: 42° | Front: 5°

Certification M2-M3 | N2-N3



Long Backrest  
Trim Upholstery - Vinyl / Cloth (cut&sew)

**STplus TV3730**

C. Width Backrest 475mm  
465mm

Fore/aft Adjustment (With Double Lock) min. 190mm

Backrest Adjustment Back: 42° | Front: 5°

Certification M2-M3 | N2-N3

Adjustable Seat Cushion



Fore and Aft: 70mm

Lumbar Adjustment



Adjustable Armrest



20mm

3P Automatic Seat Belt



Standard Covering



# STARplus TYPE

# SP12-TV5 MECHANISM

HOMOLOGATED | Scissor Type, Wide Pneumatic Suspension

- **Pneumatic Suspension** with air spring & hydraulic shock-absorber  
With 12V or 24V | 9A Built-In Compressor
- 80mm Suspension Stroke
- 50-150kg Manuel Operator Weight Adjustment
- Fore/Aft Isolator 35mm Travel
- Universal Fixing Base
- **1322/2014 (2018/830W2) EEC Homologation Certification**

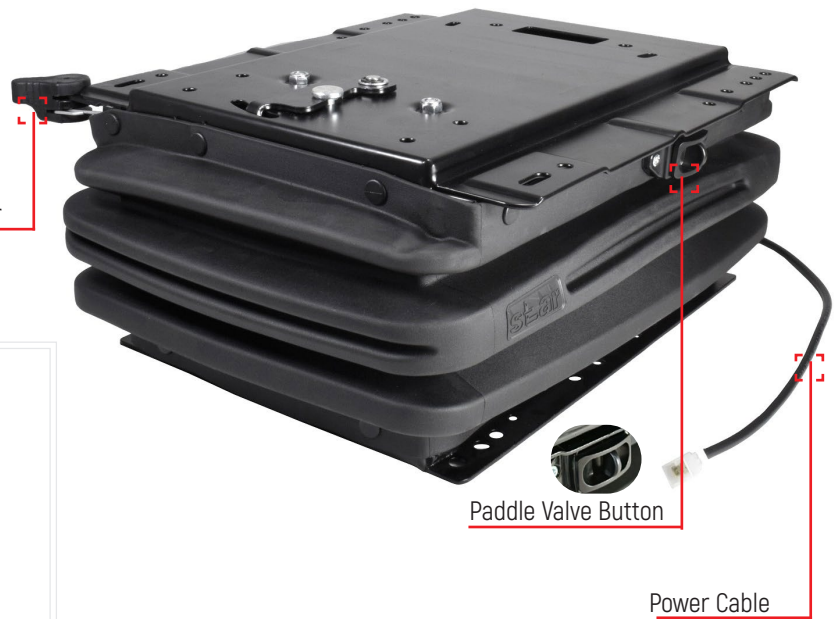

Fore/Aft Isolator

Paddle Valve Button

Power Cable

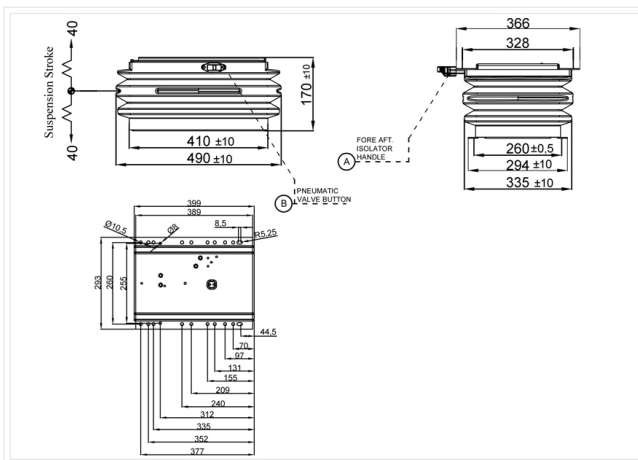

Air Springs



Hydraulic Shock Absorber



Fore/aft Isolator



Automatic Weight Adjustment



LOW Frequency Mechanism



**STplus TV5**

C. Width Backrest 475mm  
430mm

Fore/aft Adjustment min. 190mm

Backrest Adjustment Back: 30° | Front: 85°



**STplus TV5-LX**

C. Width Backrest 485mm  
475mm

Fore/aft Adjustment min. 190mm

Backrest Adjustment Back: 30° | Front: 85°



**3CTRL  
ADJUSTMENT**  
Depth | Tilt | Backrest



**STplus TV5700**

C. Width Backrest 500mm  
495mm

Fore/aft Adjustment (With Double Lock) min. 190mm

Backrest Adjustment Back: 30° | Front: 85°



**STplus TV5700 3CTRL**

C. Width Backrest 520mm  
495mm

Fore/aft Adjustment (With Double Lock) min. 190mm

Backrest Adjustment Back: 30° | Front: 85°

Seat Cushion Depth Adjustment 40mm

Seat Cushion Tilt Adjustment 6°

# STARplus TYPE

# SP12-TV6 MECHANISM

HOMOLOGATED | Scissor Type, Wide Pneumatic Suspension

- **Pneumatic Suspension** with air spring & hydraulic shock-absorber  
With 12V or 24V | 9A Built-In Compressor
- 80mm Suspension Stroke
- 50-150kg Manuel Operator Weight Adjustment
- Universal Fixing Base
- **1322/2014 (2018/830W2) EEC Homologation Certification**



Paddle Valve Button

Power Cable

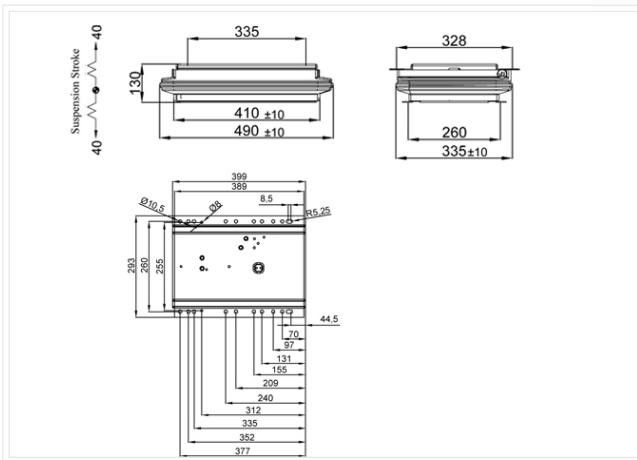

Air  
Springs



Hydraulic  
Shock  
Absorber



Fore/aft  
Isolator



Automatic  
Weight  
Adjustment



LOW  
Frequency  
Mechanism



**STplus TV6**

C. Width  
Backrest 475mm  
430mm

Fore/aft Adjustment min. 190mm

Backrest Adjustment Back: 30° | Front: 85°



**STplus TV6-LX**

C. Width  
Backrest 485mm  
475mm

Fore/aft Adjustment min. 190mm

Backrest Adjustment Back: 30° | Front: 85°



- Double Slide
- Joystick box with micro switch
- Adjustable Joystick box with gas spring for left side

Joystick handle not provide



PNEUMATIC SUSPENSION

## STplus TV3-LXJ

C. Width Backrest	485mm 475mm
-------------------	----------------

Fore/aft Adjustment (With Double Lock)	First : min. 190mm Second: min. 190mm
--	--

Backrest Adjustment	Back: 30°   Front: 85°
---------------------	------------------------

- Double Slide
- Joystick box with micro switch
- Adjustable Joystick box with gas spring for left side

Joystick handle not provide



MECHANICAL SUSPENSION

## STplus TV4-LXJ

C. Width Backrest	485mm 450mm
-------------------	----------------

Fore/aft Adjustment (With Double Lock)	First : min. 190mm Second: min. 190mm
--	--

Backrest Adjustment	Back: 30°   Front: 85°
---------------------	------------------------



MECHANICAL SUSPENSION

## STplus TV4-LX / YP28-JCB

C. Width Backrest	485mm 475mm
-------------------	----------------

Fore/aft Adjustment (With Double Lock)	min. 190mm
--	------------

Backrest Adjustment	Back: 30°   Front: 85°
---------------------	------------------------

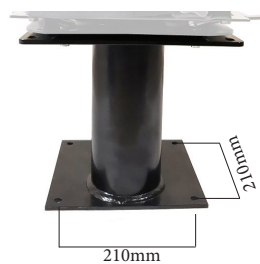

## SP 091JCS

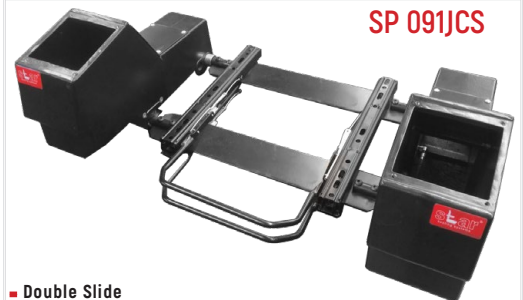

- Double Slide
- Joystick box with micro switch
- Adjustable Joystick box with gas spring for left side

- Double Slide
- Joystick box with micro switch
- Adjustable Joystick box with gas spring for left side



PNEUMATIC SUSPENSION  
Trim Upholstery - Vinyl / Cloth (cut&sew) Short Backrest

<b>STplus TV3650J</b>	C. Width Backrest	475mm 465mm
Fore/aft Adjustment (With Double Lock)	First : min. 190mm Second: min. 190mm	
Backrest Adjustment	Back: 42°   Front: 5°	
Certification	M2-M3   N2-N3	

- Double Slide
- Joystick box with micro switch
- Adjustable Joystick box with gas spring for left side



MECHANICAL SUSPENSION  
Trim Upholstery - Vinyl / Cloth (cut&sew) Short Backrest

<b>STplus TV4650J</b>	C. Width Backrest	475mm 465mm
Fore/aft Adjustment (With Double Lock)	First : min. 190mm Second: min. 190mm	
Backrest Adjustment	Back: 42°   Front: 5°	
Certification	M2-M3   N2-N3	

**NEW**

- Double Slide
- Joystick box with micro switch
- Adjustable Joystick box with gas spring for left side

\* Joystick handle not provide



MECHANICAL SUSPENSION  
**3CTRL ADJUSTMENT**  
Depth | Tilt | Backrest

<b>STplus TV4700-J</b>	C. Width Backrest	500mm 495mm
Fore/aft Adjustment (With Double Lock)	First : min. 190mm Second: min. 190mm	
Backrest Adjustment	Back: 30°   Front: 85°	

**NEW**

- Double Slide
- Joystick box with micro switch
- Adjustable Joystick box with gas spring for left side

\* Joystick handle not provide



MECHANICAL SUSPENSION  
Trim Upholstery Vinyl / Cloth (cut&sew)  
**3CTRL ADJUSTMENT**  
Depth | Tilt | Backrest

<b>STplus TV4700-J 3CTRL</b>	C. Width Backrest	520mm 495mm
Fore/aft Adjustment (With Double Lock)	First : min. 190mm Second: min. 190mm	
Backrest Adjustment	Back: 30°   Front: 85°	
Seat Cushion Depth Adjustment	40mm	
Seat Cushion Tilt Adjustment	6°	



# STARplus TYPE SP12-FSV1LS MECHANISM

Scissor Type, LOW Mechanical Suspension

- LOW Mechanical Suspension with couple springs & hydraulic shock-absorber
- 40mm Suspension Stroke
- 50-130kg Operator Weight Adjustment
- Universal Fixed Base

Weight Adjustment Knob



Weight Adjustment Indicator

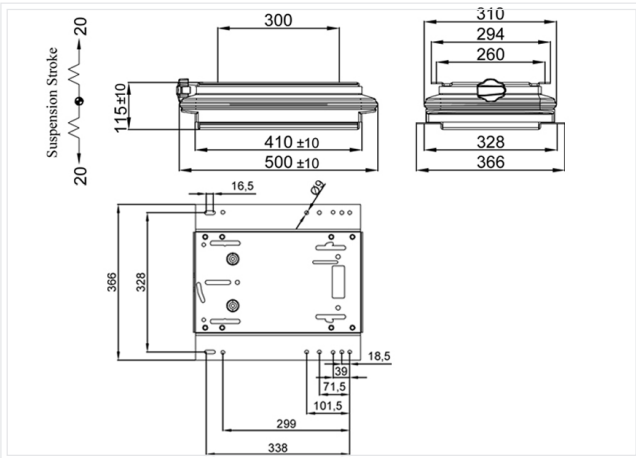

Couple Springs	Hydraulic Shock Absorber	LOW Mechanical Suspension	Manual Weight Adjustment	LOW Frequency Mechanism



**STplus FSV1LS**

C. Width Backrest 475mm  
430mm

Fore/aft Adjustment	min. 150mm
Backrest Adjustment	Back: 30°   Front: 85°

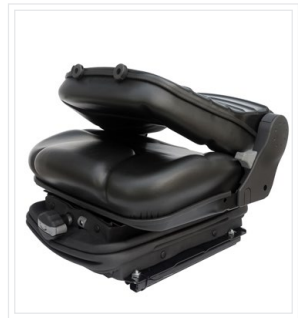

**STplus FSV1LS-LX**

C. Width Backrest 485mm  
475mm

Fore/aft Adjustment	min. 150mm
Backrest Adjustment	Back: 30°   Front: 85°



**STplus FSV140LS**

C. Width Backrest 400mm

Fore/aft Adjustment	min. 150mm
Backrest Adjustment	Back: 30° Front: 85°
Seat Cushion Depth Adj.	40mm

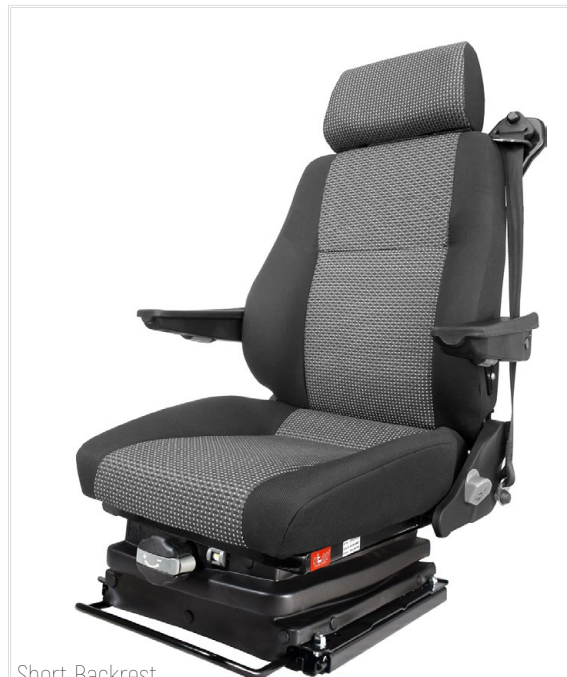
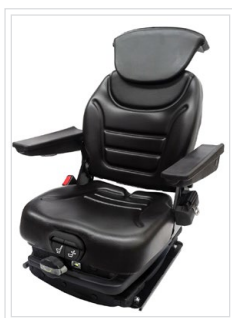

Short Backrest  
Trim Upholstery - Vinyl / Cloth (cut&sew)

**STplus FSV1650LS**

C. Width Backrest 475mm  
465mm

Fore/aft Adjustment (With Double Lock)	min. 190mm
Backrest Adjustment	Back: 42°   Front: 5°
Certification	M2-M3   N2-N3

Adjustable Seat Cushion



Fore and Aft: 70mm

Lumbar Adjustment



Adjustable Armrest

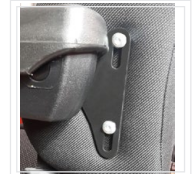

20mm

3P Automatic Seat Belt





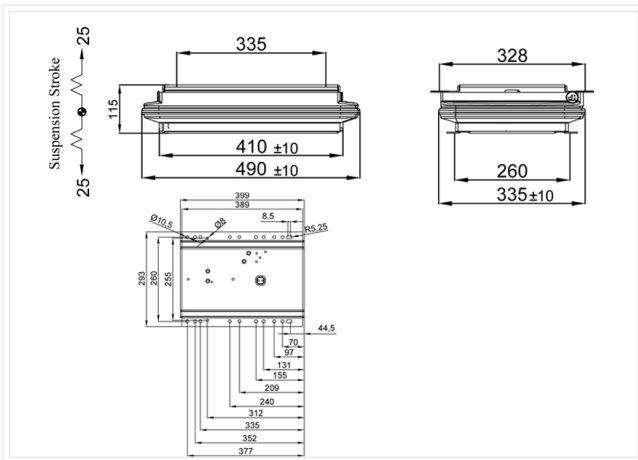
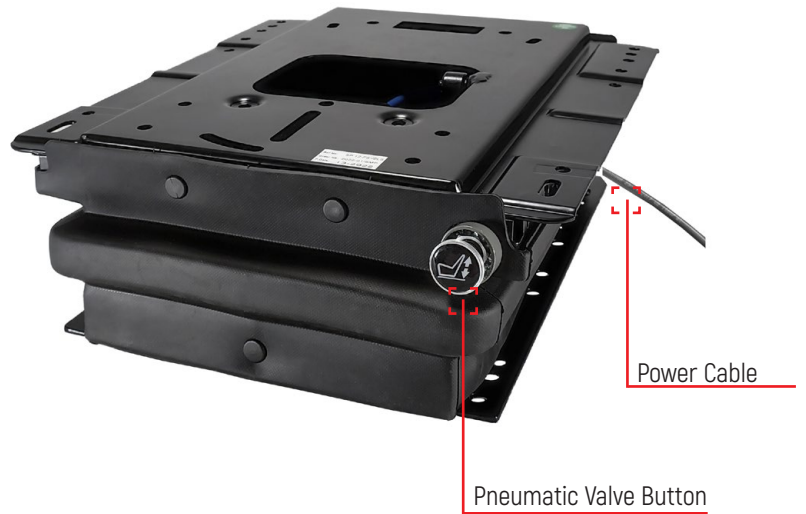

# STARplus TYPE SP12-FSV2LS MECHANISM

HOMOLOGATED | Scissor Type, LOW Pneumatic Suspension

- **LOW Pneumatic Suspension** with AIR spring & hydraulic shock-absorber  
With 12V or 24V | 9A Built-In Compressor
- 50mm Suspension Stroke
- 50-150kg Manuel Operator Weight Adjustment
- Universal Fixed Base
- **1322/2014 (2018/830W2) EEC Homologation Certification**



				
AIR Spring	Hydraulic Shock Absorber	LOW Pneumatic Suspension	Weight Adjustment	LOW Frequency Mechanism



**STplus FSV2LS**

C. Width 475mm  
Backrest 430mm

Fore/aft Adjustment min. 150mm

Backrest Adjustment Back: 30° | Front: 85°



**STplus FSV2LS-LX**

C. Width 485mm  
Backrest 475mm

Fore/aft Adjustment min. 150mm

Backrest Adjustment Back: 30° | Front: 85°



Short Backrest  
Trim Upholstery - Vinyl / Cloth (cut&sew)

**STplus FSV2650LS**

C. Width 475mm  
Backrest 465mm

Fore/aft Adjustment (With Double Lock) min. 190mm

Backrest Adjustment Back: 42° | Front: 5°

Certification M2-M3 | N2-N3

Adjustable Seat Cushion



Fore and Aft: 70mm

Lumbar Adjustment



Adjustable Armrest

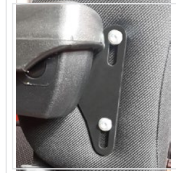

20mm

3P Automatic Seat Belt



# STARplus TYPE SP12-DRV3 MECHANISM

Scissor Type, AIR Suspension

- Automatic AIR Suspension with AIR spring & hydraulic shock-absorber
- 100mm Suspension Stroke
- 60mm Height & Tilt Adjustment
- Quick Release with ON/OFF Button
- 50-150kg Automatic Operator Weight Adjustment
- Universal Fixed Base



Tilt Adjustment Handle



Air Hose



Quick Release with ON/OFF Button

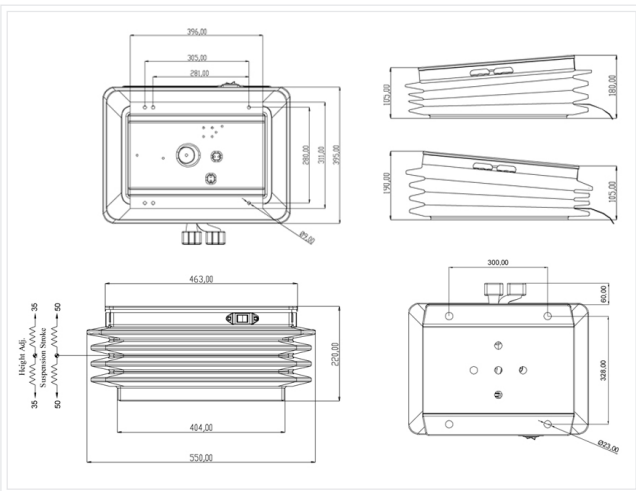

AIR Springs



Hydraulic Shock Absorber



Height Adjustment



Tilt Adjustment



Automatic Weight Adjustment



LOW Frequency Mechanism

SEAT TILT ADJUSTMENT FOR BETTER COMFORT WHILE WORKING IN STEEP ANGLES.

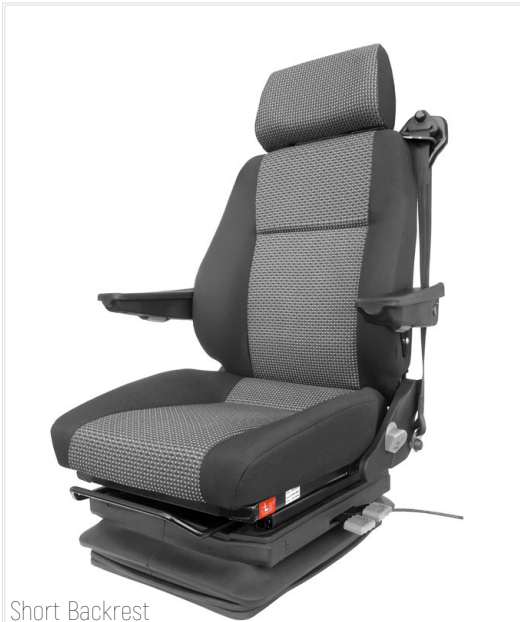

Short Backrest  
Trim Upholstery - Vinyl / Cloth (cut&sew)

<b>STplus DRV3650</b>	C. Width	475mm
	Backrest	465mm
Fore/aft Adjustment (With Double Lock)	min. 190mm	
Backrest Adjustment	Back: 42°   Front: 5°	
Certification	M2-M3   N2-N3	

Adjustable Seat Cushion  
(Fore and Aft. 70mm)



3P Automatic Seat Belt



Long Backrest  
Trim Upholstery - Vinyl / Cloth (cut&sew)

<b>STplus DRV3730</b>	C. Width	475mm
	Backrest	465mm
Fore/aft Adjustment (With Double Lock)	min. 190mm	
Backrest Adjustment	Back: 42°   Front: 5°	
Certification	M2-M3   N2-N3	

Lumbar Adjustment



Backrest Adjustment

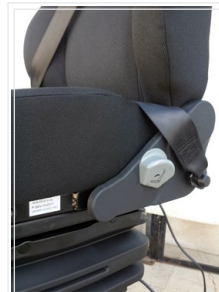

Adjustable Armrest



Standard Covering



# STAR & STARplus TYPE

## SEAT UPPERS - W/O SUSPENSION

Seats For Forklift | Agriculture | Special Vehicles

- Seat Uppers
- Without Suspension
- Universal Fixed Base



**ST 001**

C. Width  
Backrest 485mm  
480mm

Base Plate

180mm x 70mm



Wraparound Backrest

**ST 002**

C. Width  
Backrest 485mm  
570mm

Base Plate

180mm x 70mm

*Driver's seat top with/without cradle designed for general use. Designed to be universal and compatible for use with the mechanism. It provides easy installation by mounting on a flat surface with bolts. Suitable for forklifts, zero-turn mowers, loaders, dozers, graders, rollers, electric vehicles and various other machines.*





**ST 003**

C. Width Backrest 485mm  
480mm

Fore/aft Adjustment min. 150mm



Wraparound Backrest

**ST 004**

C. Width Backrest 485mm  
570mm

Fore/aft Adjustment min. 150mm

Without PVC Seal Strips



\* Plastic Construction  
\* Corrosion Resistant

**ST F00345P**

C. Width Backrest 420mm  
445mm

Fore/aft Adjustment min. 150mm



**ST F003**

C. Width Backrest 485mm  
480mm

Fore/aft Adjustment min. 150mm



**ST F003BS**

C. Width Backrest 490mm  
470mm

Fore/aft Adjustment min. 150mm

Without PVC Seal Strips



\* Plastic Construction  
\* Corrosion Resistant

**ST F00339**

C. Width Backrest 390mm

Fore/aft Adjustment min. 150mm

Without PVC Seal Strips



**ST F00342**

C. Width Backrest 420mm

Fore/aft Adjustment min. 150mm

Without PVC Seal Strips



**ST F00345**

C. Width Backrest 450mm

Fore/aft Adjustment min. 150mm

Without PVC Seal Strips



\* Plastic Construction  
\* Corrosion Resistant

**ST PF00345**

C. Width Backrest 450mm

Fore/aft Adjustment min. 150mm





Overturnable Cushion

Pan Type Seat  
Water Drainage System

<b>ST C001</b>	<b>C. Width Backrest</b>	490mm
<b>Base Plate</b>	83mm - 93mm x 120mm - 255mm	
<b>Drainage System (Rain, Snow, etc.)</b>		



Overturnable Cushion

Pan Type Seat  
Water Drainage System

<b>ST GC001</b>	<b>C. Width Backrest</b>	390mm
<b>Base Plate</b>	83mm-93mm x 120mm - 255mm	
<b>Drainage System (Rain, Snow, etc.)</b>		



Pan Type Seat  
Water Drainage System

<b>ST C006</b>	<b>C. Width Backrest</b>	390mm
<b>Fore/aft Adjustment</b>	min. 150mm	
<b>Drainage System (Rain, Snow, etc.)</b>		



Pan Type Seat  
Water Drainage System

<b>ST GC006</b>	<b>C. Width Backrest</b>	390mm
<b>Fore/aft Adjustment</b>	min. 150mm	
<b>Drainage System (Rain, Snow, etc.)</b>		



Pan Type Seat  
Water Drainage System

<b>ST YP10</b>	<b>C. Width Backrest</b>	490mm
175mm - 180mm x 145mm - 220mm		
<b>Drainage System (Rain, Snow, etc.)</b>		



Pan Type Seat  
Water Drainage System

<b>ST YP11</b>	<b>C. Width Backrest</b>	390mm
175mm - 180mm x 145mm - 220mm		
<b>Drainage System (Rain, Snow, etc.)</b>		



<b>STplus FS10</b>	<b>C. Width Backrest</b>	475mm 430mm
<b>Fore/aft Adjustment</b>	min. 150mm	
<b>Backrest Adjustment</b>	Back: 13°   Front: 3°	



<b>STplus FS11</b>	<b>C. Width Backrest</b>	475mm 430mm
<b>Fore/aft Adjustment</b>	min. 150mm	
<b>Backrest Adjustment</b>	FIXED	



<b>STplus FS12</b>	<b>C. Width Backrest</b>	475mm 430mm
<b>Fore/aft Adjustment</b>	min. 150mm	
<b>Backrest Adjustment</b>	Back: 13°   Front: 3°	
<b>Mechanical Suspension</b>	40mm Suspension Stroke With Couple Spring	
<b>Weight Adjustment</b>	50kg-130kg	



**STplus FSV1LX**

C. Width  
Backrest 485mm  
475mm

Fore/aft Adjustment	min. 150mm
Backrest Adjustment	Back: 30°   Front: 85°

**STplus FSV1**

C. Width  
Backrest 475mm  
430mm

Fore/aft Adjustment	min. 150mm
Backrest Adjustment	Back: 30°   Front: 85°

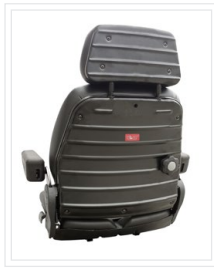

**STplus FSV140**

C. Width  
Backrest 420mm

Fore/aft Adjustment	min. 150mm
Backrest Adjustment	Back: 30°   Front: 85°
Seat Cushion Depth Adj.	40mm



**STplus FSV152-3CTRL**

C. Width  
Backrest 520mm  
445mm

Fore/aft Adjustment (With Double Lock)	min. 190mm
Backrest Adjustment	Back: 30°   Front: 85°
Seat Cushion Depth Adjustment	40mm
Seat Cushion Tilt Adjustment	6°



Trim Upholstery - Vinyl / Cloth (cut&sew)

**STplus SSV1600F**

C. Width  
Backrest 510mm  
495mm

Fore/aft Adjustment (With Double Lock)	190mm
Backrest Adjustment	Back: 80°   Front: 30°

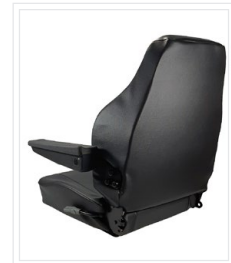

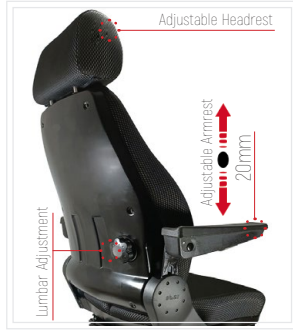
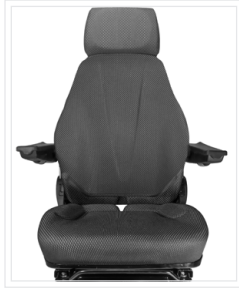

**STplus FSV1700**

C. Width Backrest 500mm  
495mm

Fore/aft Adjustment  
(With Double Lock)

min. 190mm

Backrest Adjustment

Back: 30° | Front: 85°

**3CTRL  
ADJUSTMENT**  
Depth | Tilt | Backrest



**STplus FSV1700 3CTRL**

C. Width Backrest 520mm  
495mm

Fore/aft Adjustment  
(With Double Lock)

min. 190mm

Backrest Adjustment

Back: 30° | Front: 85°

Seat Cushion Depth Adjustment

40mm

Seat Cushion Tilt Adjustment

6°

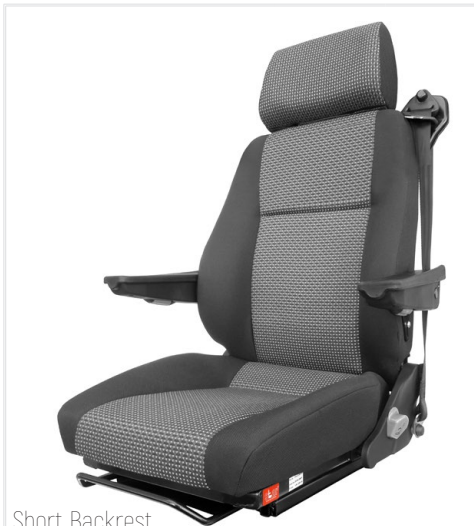

Short Backrest  
Trim Upholstery - Vinyl / Cloth (cut&sew)

**STplus DST1650F**

C. Width Backrest 475mm  
465mm

Fore/aft Adjustment

min. 190mm

Backrest Adjustment

Back: 42° | Front: 5°

Certification

M2-M3 | N2-N3



Long Backrest  
Trim Upholstery - Vinyl / Cloth (cut&sew)

**STplus DST1730F**

C. Width Backrest 475mm  
465mm

Fore/aft Adjustment

min. 190mm

Backrest Adjustment

Back: 42° | Front: 5°

Certification

M2-M3 | N2-N3

Lumbar Adjustment



3P Automatic Seat Belt



Adjustable Armrest



Standard Covering



STAR TYPE

# TRACTOR PASSENGER SEAT

Seats For Tractor & Special Vehicles



Overturnable Cushion

**STP-0100JD**

C. Width Backrest	356mm 280mm
----------------------	----------------

JOHN DEERE: 6000-6010-6020-6030-6M-7010-7020-SE Series  
- KUBOTA: M130X - SAME DEUTZ: AGROPLUS 410 - MASSEY FERGUSON



Overturnable Cushion

**STP-0200ZTR**

C. Width Backrest	356mm 280mm
----------------------	----------------

ZETOR Forterra Series: FCL, F HSX, F HD - ZETOR Proxima Series: PROXIMA, PROXIMA PLUS, PROXIMA POWER



Overturnable Cushion

**STP-500TMS**

C. Width	375mm
----------	-------

Universal Type



Overturnable Cushion

**STP-0400TD**

C. Width Backrest	390mm 260mm
----------------------	----------------

New Holland TD Series - T4 Series



Overturnable Cushion

**STP-0399**

C. Width	356mm
----------	-------

Universal Type



Overturnable Cushion

<b>STP-M108K</b>	C. Width Backrest	356mm 280mm
KUBOTA M108 Series		



Overturnable Cushion



<b>STP-M9545K</b>	C. Width Backrest	280mm 280mm
KUBOTA M9540, M8540, M6040, M7040 Series		

# STAR TYPE TRACTOR KID SEAT

Seats For Tractor & Special Vehicles

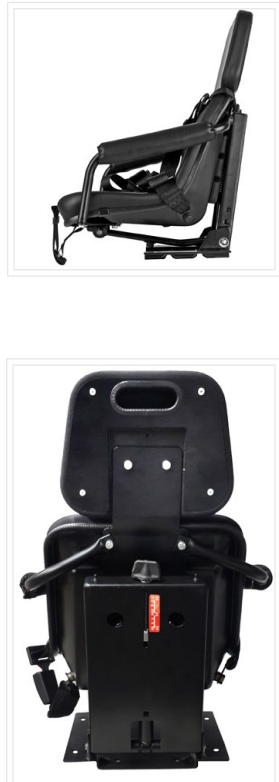

<b>STP-GC11KID</b>	C. Width Backrest	390mm
Mechanical Suspension with couple springs & hydraulic shock-absorber		
Suspension Stroke 50mm		
Base Plate	365mm x 140mm	
5Point Static Seat Belt	Standart	

<b>STP-YP11KID</b>	C. Width Backrest	390mm
Without Suspension		
Base Plate	395mm x 140mm	
5Point Static Seat Belt	Standart	

STAR TYPE

# PLASTIC CONSTRUCTION

Seats For Agriculture | Gator | Lawn & Garden Special Vehicles



## Ergonomic and Comfortable Backrest

- Durable blow molded plastic frame
- Ergonomic cushion with seamless design
- Vacuum formed waterproof vinyl
- Multi-hole mounting pattern
- Corrosion Resistant
- Operator presence switch installation available





21" High-Back Seat

<b>ST 2146</b>	C. Width Backrest	460mm
----------------	-------------------	-------

Drainage System (Rain, Snow, etc.)



21" High-Back Seat

<b>ST F2146</b>	C. Width Backrest	460mm
-----------------	-------------------	-------

Drainage System (Rain, Snow, etc.)

Fore/aft Adjustment min. 150mm



18" High-Back Seat

<b>ST 1846</b>	C. Width Backrest	460mm
----------------	-------------------	-------

Drainage System (Rain, Snow, etc.)



18" High-Back Seat

<b>ST F1846</b>	C. Width Backrest	460mm
-----------------	-------------------	-------

Drainage System (Rain, Snow, etc.)

Fore/aft Adjustment min. 150mm



18" High-Back Seat

<b>ST 1846 CAMO</b>	C. Width Backrest	460mm
---------------------	-------------------	-------

Drainage System (Rain, Snow, etc.)



15" Back Seat

<b>ST 1546</b>	C. Width Backrest	450mm
----------------	-------------------	-------

Drainage System (Rain, Snow, etc.)



15" Back Seat

<b>ST F1546</b>	C. Width Backrest	450mm
-----------------	-------------------	-------

Drainage System (Rain, Snow, etc.)

Fore/aft Adjustment min. 150mm



15" Back Seat

<b>ST 1546 CAMO</b>	C. Width Backrest	450mm
---------------------	-------------------	-------

Drainage System (Rain, Snow, etc.)





15" Back Seat

<b>ST 1545MI</b>	C. Width Backrest	460mm
------------------	-------------------	-------

Drainage System (Rain, Snow, etc.)

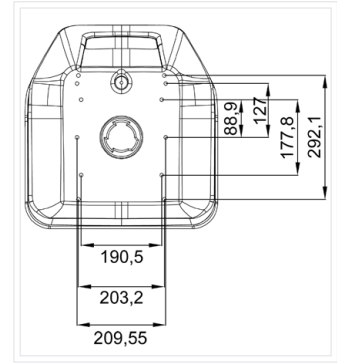

15" Back Seat

<b>ST 1548MB</b>	C. Width Backrest	480mm 460mm
------------------	-------------------	----------------

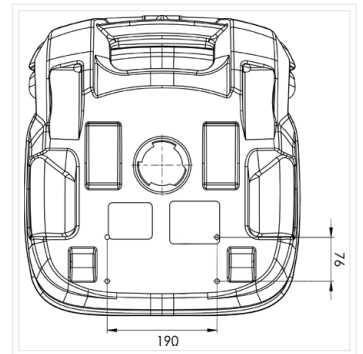



## AKS01

2 Cylinders

Pressure: 8 bar

Tractor PTO speed: 540 rpm

Stroke: 42 mm

Net Weight: 9 kgs - Gross Weight: 10 kgs

With 4 meters special air-hose free



**WARNING!**  
**OIL FREE**

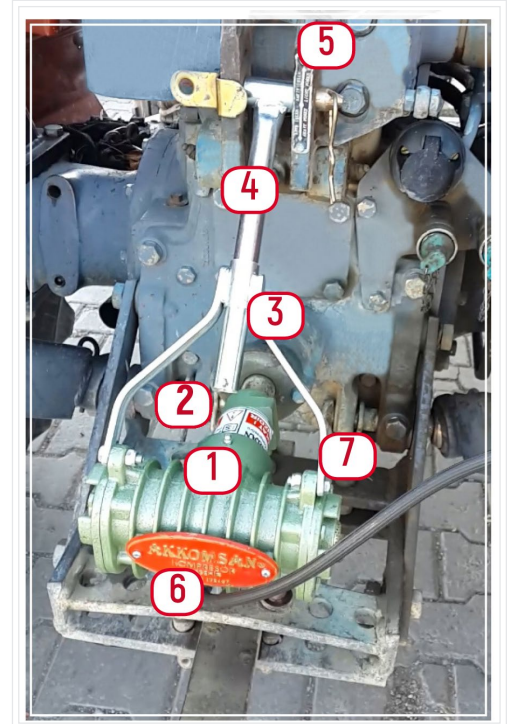

***"It is adaptable for a lot of type tractors."***

- Before using your compressor, firstly you have to inject 60 gr grease oil from the screw of grease. (Number 1)  
(Pumping the grease pump 20 times is approximately 100 gr.)
- Connect the compressor to your tractor using the special lock. (Number 2)
- Connect the pieces to the back of your tractor. (Number 3 & 4)
- To secure your compressor, connect it to the upper lift lever with the drawbar base pin. (Number 5).
- Set the air hose first to your compressor and then to your wheel with the special nut. (Number 6)
- You can start using the compressor by keeping PTO (Power Transportation Organ) of the tractor between 300-400 cycles.
- Check the bolts and nuts periodically. (Number 7)
- Keep the compressor in its original box to protect it from water, dust, and dirtiness, etc. after every use.



Designing, Engineering and Manufacturing

Great Range of Exclusive Drive Seats for you



We are at your side with a solution-oriented approach in all projects from design to R&D, from mold manufacturing to mass production processes for your special vehicles.

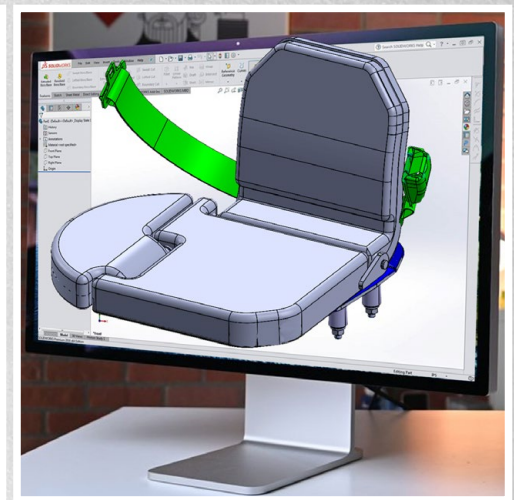

**MECHANISM** \*L Type, Scissor Type (Mechanical, Pneumatic Systems)

**L Type Suspension Mechanism**



ECO-01SM



ECO-03SM



ECO-11SM



ECO 11-05SM



03SM



11SM



05SM

**Scissor Type Suspension Mechanism ( Narrow, Wide / Mechanical, Pneumatic)**



SP 12-TV1



SP 12-TV4



SP 12-FSV1LS



SP 12-TV2



SP 12-TV3



SP 12-TV5



SP 12-TV6



SP 12-FSV2LS



SP 12-DRV3

**CUSHION**

\*Polyurethane driver's seat and backrest with vacuumable or sewable models, designed for various classes of tractors and construction equipment.

<p><b>ECO SERIES</b></p>	 <p><b>ST EYP1</b> Seat Cushion</p> <p><b>ST EYP2A</b> Wraparound Cushion</p>	 <p><b>ST EYP1P</b> Seat Cushion Plastic Construction</p> <p><b>ST EYP2A</b> Backrest Cushion Metal Construction</p>	 <p><b>ST EYP1</b> Seat Cushion</p> <p><b>ST EYP2</b> Backrest Cushion</p>	<p>Plastic Construction</p>  <p><b>ST EYP1P</b> Seat Cushion</p> <p><b>ST EYP2P</b> Backrest Cushion</p>
<p><b>STAR SERIES</b></p>	 <p><b>ST YP1</b> Seat Cushion</p> <p><b>ST YP2A</b> Wraparound Cushion</p>	 <p><b>ST YP1</b> Seat Cushion</p> <p><b>ST YP2</b> Backrest Cushion</p>	 <p><b>ST YP1BS</b> Seat Cushion</p> <p><b>ST YP2BS</b> Backrest Cushion</p>	
<p><b>STPlus SERIES</b></p>	 <p><b>ST YPV1</b> Seat Cushion</p> <p><b>ST YPV2</b> Backrest Cushion</p>	 <p><b>ST YPV1LX</b> Seat Cushion</p> <p><b>ST YPV2LX</b> Backrest Cushion</p>	 <p><b>ST YPV1700</b> Seat Cushion</p> <p><b>ST YPV2700</b> Backrest Cushion</p>	 <p><b>ST YPV1-3CTRL</b> Seat Cushion with sheet</p>
	 <p><b>ST YPV1FS</b> Seat Cushion</p> <p><b>ST YPV2FS</b> Backrest Cushion</p>			
<p><b>COMPACT SERIES</b></p>	 <p><b>ST YP139</b> Seat Cushion Foam</p> <p><b>ST YP239</b> Backrest Cushion Foam</p>	 <p><b>ST YPV140</b> Seat Cushion Foam</p> <p><b>ST YPV240</b> Backrest Cushion Foam</p>	 <p><b>ST YP142</b> Seat Cushion Foam</p> <p><b>ST YP242</b> Backrest Cushion Foam</p>	 <p><b>ST YP145</b> Seat Cushion Foam</p> <p><b>ST YP245</b> Backrest Foam</p>
	<p>Plastic Construction For Seat Top</p>  <p><b>ST YP145P</b> Seat Cushion</p> <p><b>ST YP245P</b> Backrest Cushion</p>			
<p><b>PAN TYPE SERIES</b></p>	 <p><b>ST YP11</b> Seat Cushion Drainage System With Holes</p>	 <p><b>ST YP10</b> Seat Cushion Drainage System With Holes</p>		

**PLASTICS PARTS**

\*Protection plastic, slide adjustment plastic, backrest adjustment handle...

 <p><b>YP 26</b> Plastic Cover</p>	 <p><b>YP 13</b> Plastics Guide</p>	 <p><b>YP12</b> Plastic Rollers</p>	 <p><b>YP 16</b> Height Adjustment Plastic</p>	 <p><b>SP 09</b> Weight Adjustment Handle</p>
 <p><b>SP52R SP53L</b> Plastic Side Cover Right - Left</p>	 <p><b>SP52700R SP53700L</b> Plastic Side Cover Right - Left</p>	 <p><b>SP 52-DRV3-R SP 52-DRV3-L</b> Plastic Side Cover Right - Left</p>	 <p><b>SP 72R With Spring SP 72L W/O Spring</b> Headrest Adjustable Plastics</p>	 <p><b>SP 64</b> DRV Mechanism Plastic</p>
 <p><b>SP 69</b> Horizontal Sus. Plastic</p>	 <p><b>SP 93</b> Seat Cushion Assembly Plastics</p>	 <p><b>SP 16-DRV</b> DRV Backrest Adjustment Plastic</p>	 <p><b>SP 17-DRV3</b> DRV Tilt Adjustment Handle</p>	 <p><b>SP 16-H40</b> Plastic Kit, Backrest Adj. - Fore/Aft Handle</p>
 <p><b>SP 16-3CTRL</b> Adjustment Handle Set With Rope</p>	 <p><b>MK23 SET 10pcs</b> Seat Cushion Fixing Plastic Kit</p>	 <p><b>SP 58</b> Fore and Aft. Suspension Handle Set</p>		





**ADJUSTMENT HANDLES**

\*For your logo; embroidery, screen printing can be applied.

 <p><b>YP7 ECO</b> Weight Adj. Lever</p>	 <p><b>YP7</b> Weight Adj. Lever With Hook</p>	 <p><b>SP 09SC</b> Weight Adjustment Hook With Indicator</p>	 <p><b>SP 10</b> Height Adjustment Handle</p>	 <p><b>SP 09LS</b> Weight Adjustment Hook With Indicator</p>
--	---	---	---	---

**SLIDE RAILS**

\*With its solid structure, it prevents wear during the operation of your seat and provides a comfortable driving experience..

 <p><b>SP 14/325</b> Slider</p>	 <p><b>SP 13LD/200</b> Slider With Double Lock</p>	 <p><b>SP 13/300</b> Slider With Locked</p>	 <p><b>SP 094</b> Lateral Suspension</p>
---	---	--	--

**SPRINGS**

\*Designed to be durable, long-lasting for suspension.



**YP 6ECO**  
Suspension Springs (1pcs)



**YP6**  
Suspension Springs (1pcs)



**YP 23**  
Slide Spring



**SP 04-TV1**  
Narrow Mechanism Spring



**SP 04-TV4**  
Wide Mechanism Spring



**SP 04-LS**  
LOW Mechanism Spring (1pcs)



**SP 04HR**  
Horizontal Suspension Spring



**SP 04-FS12 SET**  
Spring

**SHOCK ABSORBER**

\*It significantly reduces vibrations and provides a comfortable and healthy drive.



**YP5 ECO**  
Hydraulic Shock Absorber



**YP5**  
Hydraulic Shock Absorber



**SP 03**  
Hydraulic Shock Absorber



**YP5-TV4**  
Hydraulic Shock Absorber



**YP5 LS**  
Hydraulic Shock Absorber



**SP 03H**  
Horizontal Suspension Hydraulic Shock Absorber

**PNEUMATIC EQUIPMENT**

\*Increase your driving pleasure with cool driver seat equipment.



**SP 48**  
Air Control Valve



**SP 48P**  
Air Control Valve



**SP 47**  
12V/24V Air Compressor



**TV2AS**  
AIR Suspension Set



**SP 27**  
Air Spring



**SP 48-DRV3**  
DRV Air Control Button ON/OFF



**SP 49-DRV3**  
DRV Air Quick Release

**RUBBER BELLOW**

\*Rubber bellows that protects your mechanism system from dirt, dust, etc. harmful substances.



**SP 05-TV1**  
Rubber Bellow [Narrow Suspension]



**SP 05-TV3**  
Rubber Bellow [Wide Suspension]



**SP 05-DRV**  
Rubber Bellow [AIR Suspension]



**SP 05-LS**  
Rubber Bellow [Low Suspension]

**ARMREST** \* Fixed, Foldable and Height Adjustment model.



**ST YP15 / YP15S**  
Foldable Armrest With Bracked



**SP 02 SET**  
Foldable Armrest



**SP 0240 SET**  
Foldable Armrest



**SP 02FS SET**  
Foldable Armrest



**SP 02700J SET**  
Foldable Armrest, Height Adjustment



**SP 023 SET**  
Foldable Armrest, Height Adjustment



**SP 02700 SET**  
Foldable Armrest, Height Adjustment

**ARMREST 300** \* Fixed, Foldable and Height Adjustment model.



**SP 02300 SET**  
Foldable Armrest



**SP 0240300 SET**  
Foldable Armrest



**SP 02DR300 SET**  
Foldable Armrest, Height Adjustment



**SP 023003 SET**  
Foldable Armrest, Height Adjustment



**SP 02300700 SET**  
Foldable Armrest, Height Adjustment



**SP 02300PLS SET**  
Foldable Armrest

**ARMREST ARN** \*Adjustable Armrest Series. Angle adjustable, height adjustable models.



**ARMREST ARN 350** \*Adjustable Armrest Series. Angle adjustable, height adjustable models.



**ARMREST ARN 380** \*Adjustable Armrest Series. Angle adjustable, height adjustable models.





**HEADREST** \*For your logo; embroidery, screen printing can be applied.



**SP 01**  
Backrest Extension



**SP 01AH**  
Adjustable Backrest Extension



**SP 01AHD**  
Adjustable Headrest

**SEAT BELT** \*Compatible with all models and certified 1-point, 2-point anchor, 3-point anchor, 5-point anchor models



**SB 010**  
2P Static Seat Belt



**SB 020**  
2P Automatic Seat Belt



**SB 02010**  
2P Automatic Seat Belt



**SB 020K<sup>SENSOR</sup>**  
2P Automatic Seat Belt



**SB 030**  
3P Automatic Seat Belt



**SB 03010**  
3P Automatic Seat Belt



**SB 050**  
5P Static Seat Belt

**SWIVEL MECHANISM** \*This rotating mechanism prevents strain on neck and back muscles, and facilitates entry and exit from the cabin.



**STT-17**  
360° Swivel Mechanism (Narrow)



**LTT-18**  
360° Swivel Mechanism (Large)



**NGTT-19**  
Swivel Mechanism

**SAFETY SWITCH** \*Vehicle seat security system that detects that the operator is in the seat.



**SS 01**  
Operator Presence Switch



**DTS 01**  
Operator Presence Switch



**DTS 02750B**  
Operator Presence Switch



**DST 01CF**  
Operator Diagnostic Presence Switch Set



**DST 01CM**  
Operator Diagnostic Presence Switch Set

**MOUNTAIGE, BRACKET** \*Universal mounting bracket for external use



**YP 28/260**  
260mm Base Plate



**YP 28/FIAT**  
Base Plate



**YP 28/STYRE**  
Base Plate



**YP 28/TMS**  
Base Plate



**YP 28-KBT**  
KUBOTA Base Plate



**YP28JD**  
John Deere Base Plate

**COMFORT EQUIPMENT** \*Utility materials that make your ride comfortable



**SP 71**  
Heating PADS for Backrest/Cushion  
12V & 24V



**DB 01**  
Document Plastic Bag



**DB 02-0**  
325mm Document Bag



**DB 02-K**  
325mm Document Bag

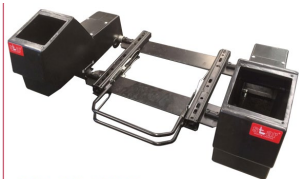

**SP 091JCS**  
JOYSTICK BOX  
ADJUSTABLE JOYSTICK BOX WITH GAS SPRING FOR LEFT



**SP 090**  
5V 2.1A - USB Charger

# SEWABLE PRODUCTS

BLACK CLOTH

SPRINTER CLOTH

BLACK VINYL

BROWN VINYL

# Right Choice

## CLOTH UPHOLSTERY COLORS



## VINYL UPHOLSTERY COLORS

- Non-Flammability - High Mechanical & Physical Strength

Vacuuable - Waterproof Vinyl - UV Resistant



### Standart Covering



Quality  
Product!



"STAR is a trademark of AKKOMSAN"

# AKKOMSAN OTOMOTIV

YEDEK PARÇA İMALATI İNS. PET. URN. SAN. VE TIC. LTD. STİ.

Reis Mahallesi, Organize Sanayi Bölgesi 2. Sokak No: 1

42560 Akşehir, KONYA / TÜRKİYE

+90 332 813 83 96 , +90 332 812 99 99